



RIADIACA JEDNOTKA SG-BWS-T4-MT

Sérii SG-BWS-T4-MT

SG-BWS-T4-MT

Bezpec.relé/Plc/kat3/4in/2out/muting

- Možno pripojiť až 4 páry bezpečnostných fotoelektrických snímačov a zároveň až dve bezpečnostné svetelné závory
- EDM
- Muting
- 2 bezpečnostné reléové výstupy NO
- Odnímateľné svorky



POPIS PRODUKTU

Riadiaca jednotka umožňuje pripojiť až štyri páry bezpečnostných fotoelektrických snímačov a súčasne až dve bezpečnostné svetelné závory alebo iné bezpečnostné zariadenia s bezpečnostnými výstupmi. Jednotka má dva nezávislé vstupy pre vypínanie a umožňuje nastaviť dve nezávislé zóny. Funkcia OVERRIDE dovoľuje posunúť tovar, ktorý uviazol v kontrolovanej oblasti. Riadiaca jednotka má dva reléové bezpečnostné výstupy a odpojiteľné svorky. Na zobrazenie stavu a diagnostiky slúži 7 segmentový LED displej.

ŠPECIFIKÁCIA

DC	99 %
Hmotnosť	370 g
Materiál tela	Nylon
Max. dĺžka kábla	50 m
Mttd	183 year
Napájacie napätie	24 V DC
PL	e (EN ISO 13849-1)
Prevádzková teplota max.	55 °C
Prevádzková teplota min.	0 °C
SIL	3 (EN IEC 62061)
Spotreba	3,8 W max
Spotreba	3,8 W
T1 (životnosť v rokoch)	20

Teplota skladovania do	70 °C
Teplota skladovania od	-25 °C
Tolerancia napätia	±15 %
Trieda krytia	IP20
V súlade s	EMC, LVD, MD
Výstupný prúd max.	3,6 A
Zhoda s normami	CE, cULus, TÜV

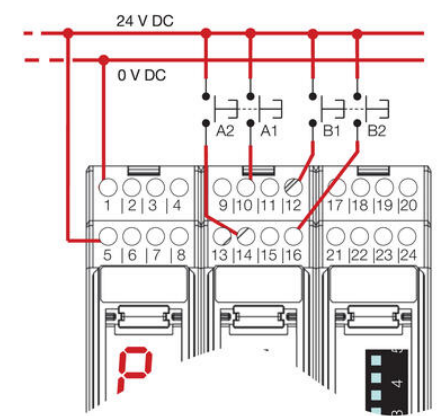
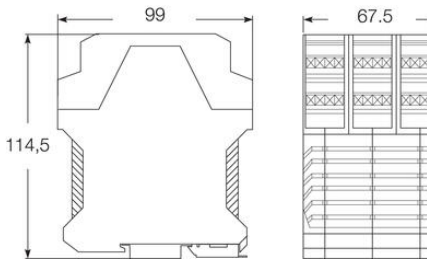
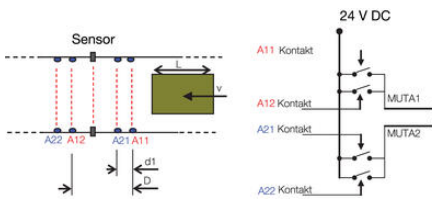
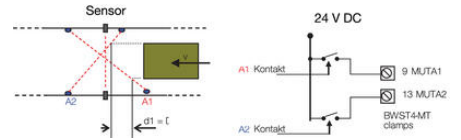
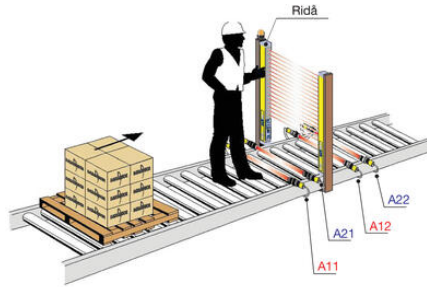
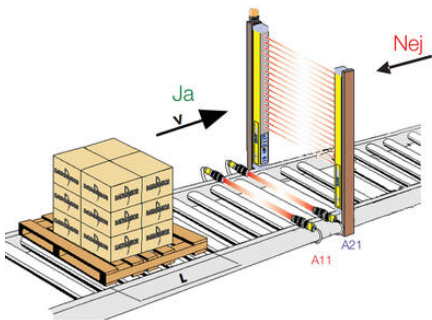

DIP	PURPOSE	OFF (Default)	ON
1	ENABLE EDM	ENABLED	DISABLED
2	RESET MODE	AUTOMATIC	MANUAL
3	MUTING TIME -OUT	10 MINUTES	INFINITY
4	MUTING DIRECTION	T	L
2	TRIGGER OVERRIDE	LEVEL	FRONT
6	MUTING SELECTION	See table below	
7	MUTING SELECTION		
8	MUTING SELECTION		

DIP-SWITCH SETUP	PHOTOCELLS	LIGHT CURTAIN 1	LIGHT CURTAIN 2
000	A	A	A
001	A	A	B
010	A	B	B
011	-	A	B
100	A	B	-
101	-	A	A
110	A	-	-
111	-	-	-

0=OFF, 1=ON, A(B) =Device associated to channel A(B)
Default setting: 000

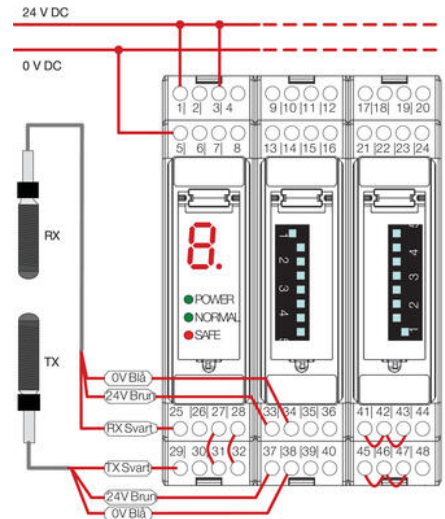

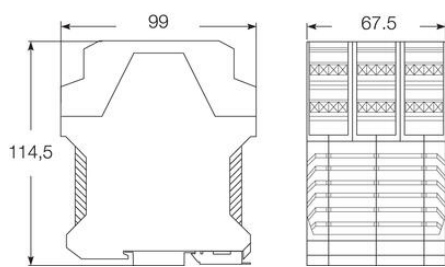
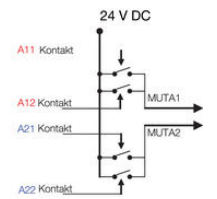
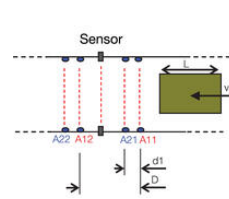
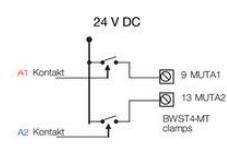
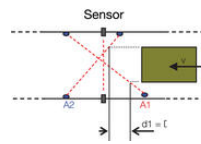
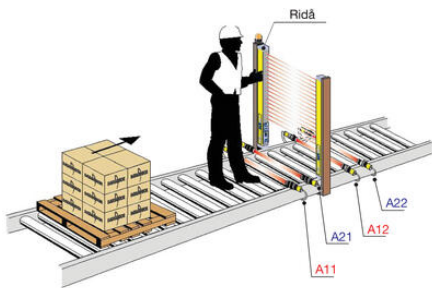
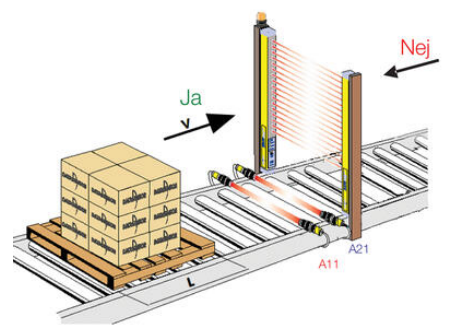
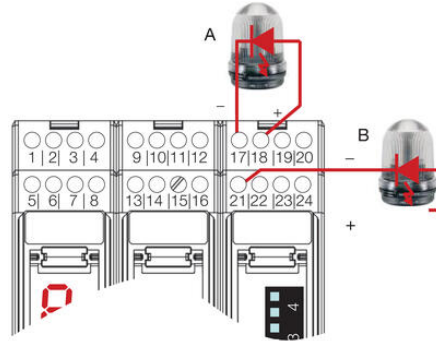
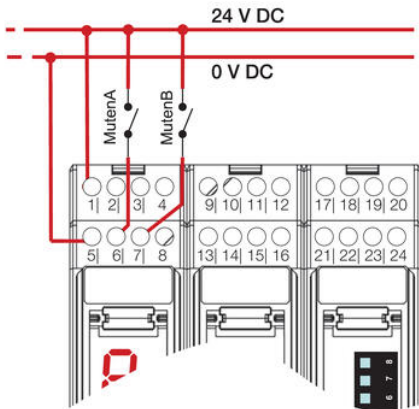
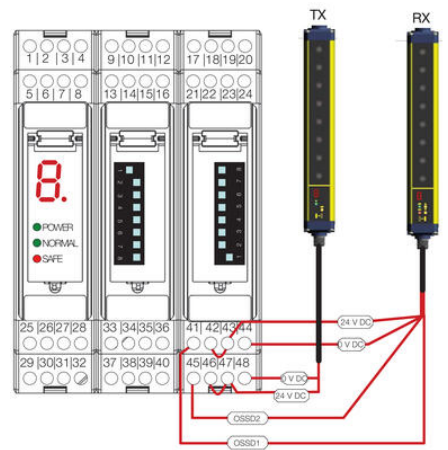
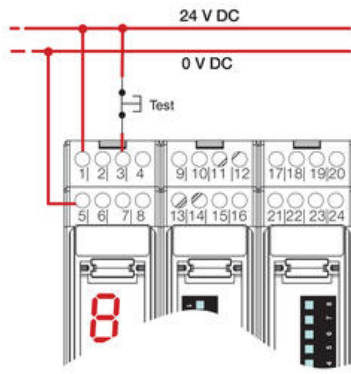
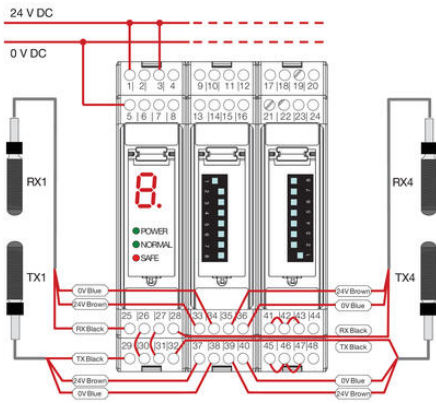

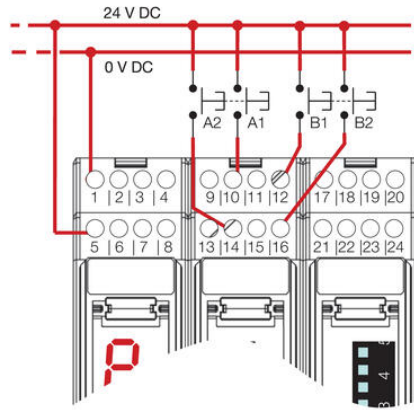

DIP	PURPOSE	OFF (Default)	ON
1	ENABLE EDM	ENABLED	DISABLED
2	RESET MODE	AUTOMATIC	MANUAL
3	MUTING TIME - OUT	10 MINUTES	INFINITY
4	MUTING DIRECTION	T	L
2	TRIGGER OVERRIDE	LEVEL	FRONT
6	MUTING SELECTION	See table below	
7	MUTING SELECTION		
8	MUTING SELECTION		

DIP-SWITCH SETUP	PHOTOCELLS	LIGHT CURTAIN 1	LIGHT CURTAIN 2
000	A	A	A
001	A	A	B
010	A	B	B
011	-	A	B
100	A	B	-
101	-	A	A
110	A	-	-
111	-	-	-

0=OFF, 1=ON, A[B] =Device associated to channel A[B]
Default settings: 000

